

TOSHIBA

Leading Innovation >>>

TOSHIBA Standard Type

Moving Walk Instruction Manual

For Operation Management

Please read this instruction manual carefully before operation
for correct and safe use,
and keep the manual handy for future reference.

Thank you very much for purchasing Toshiba Moving Walk. In order to ensure the Moving Walk's safe operation, periodic maintenances are required. However, regular inspection by the operator on a daily basis is necessary too.

Please assign operator to be in charge of the Moving Walk's operation.

To ensure Moving Walk is operated correctly and safely, the operator must read through this "Instruction Manual" carefully before operation.

After the operator has finished reading this manual, they should keep it where accessible.

When the owner or the operator is changed, please make sure that this manual is handed over to the next owner or operator.

If you have any questions or any descriptions are unclear, please inquire at our local distributor.

This manual is intended as a guide to maintenance and operation of Toshiba Moving Walk.

Terms and Definitions

The owner is the person who owns the Moving Walk.

The operator is the person who directly manages the operation of Moving Walks in use.

The engineer is the person with professional qualifications who is in charge of the maintenance of the Moving Walk.

Please enter into a maintenance contract with our local distributor, to assure your satisfaction with high quality maintenance services.

Ensure quality performance and operation of your Moving Walk.

- We understand the overall structure of the Moving Walk clearly, including the design, manufacture, sales, installation, maintenance, and the correct technical information. Our service has quality assurance.

Ensure efficient repair and parts replacement.

- We supply appropriate parts according to the model and all parts are in stock. Repair service and part replacement are done efficiently.

Fast-action servicing.

- In case of malfunction or emergency, our engineers will be there to fix the problem in a timely manner.

Serviced by professionals.



- Your Moving Walk is always maintained by professionals. Only engineers who possess the technical skills and qualifications will be assigned to take charge of the Moving Walk's maintenance.

Introduction	1
Definition of Safety Indications	3
Safety Precautions	4
Safety Devices	11
Names and Functions of Moving Walk Parts	13
Operating Procedures	15
Startup	15
Shutdown	16
How to Ride a Moving Walk Safely	17
Safety Measures in Case of Emergency	19
In Case of Emergency Stop	19
In Case of Accident Resulting in Injury or Death.....	20
Examples of Rescue Methods	20
Safety Measures in Case of Disaster	21
In Case of Earthquake	21
In Case of Fire.....	22
Power Outage Notification.....	23
In Case of Rainstorm.....	24
Procedure for Daily Inspection	25
How to Clean and Maintain Moving Walks.....	27
Guidelines on the Maintenance and Operation of Moving Walks	29

Definition of Safety Indications

Be aware of the following safety indications and their meaning. These indications are very important in prompting operator and passengers awareness about hazardous actions or locations.

Description of labels



Label	Meaning of label
 DANGER	Indicates "If erroneously handled, there is an immediate risk that persons may die or be seriously injured".
 WARNING	Indicates "If erroneously handled, persons may die or be seriously injured *1".
 CAUTION	Indicates "If erroneously handled, persons may be injured*2 and/or only material damage*3 may occur".

*1: "Seriously injured" means blindness, injury, burns (high-temperature and moderate-temperature), electric shock, fractures, poisoning, etc. with long-lasting effects and that require hospitalization and/or long-term hospital visits for treatments.

*2: "Injured" means an injury, burns, electric shock, etc. that require hospitalization and/or long-term hospital visits for treatments.

*3: "Material damage" means extended damage involving assets and materials, and/or involving livestock and pets.

Description of symbols

Symbol	Meaning of symbol
 Prohibited	"⊘" indicates a prohibited action (a forbidden action). The nature of the hazard is depicted in the form of an image or a sentence within or near the symbol.
 Mandatory Action	"●" indicates a mandatory action (a compulsory action). The nature of the hazard is depicted in the form of an image or a sentence within or near the symbol.

Important notes:

Be sure to observe all safety precautions marked with the DANGER, WARNING and CAUTION labels, and do not do anything that is not described in this manual in order to avoid injury, death or property damage.

Disclaimer













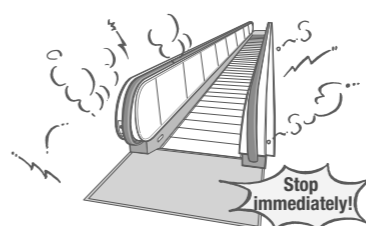

Toshiba shall not be responsible for any breakdowns or accidents caused by inappropriate management or usage, including but not limited to the following:

- Failure to follow or apply the operating or handling instructions contained herein
- Inappropriate maintenance, inspections and/or repairs
- Unauthorized alterations to the Moving Walk
- Use of parts other than those provided or specified by Toshiba

Safety Precautions



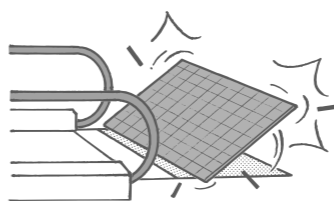

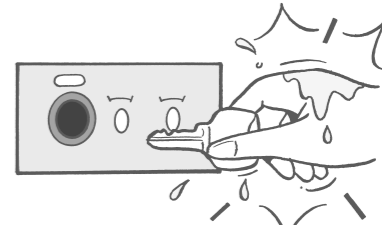
The following precautions apply to the Owner and the Operator of Moving Walks.

WARNING



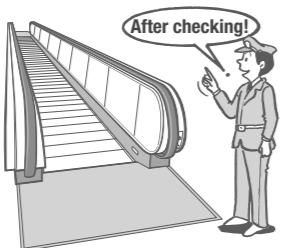

<p>■ Perform daily inspection (Refer to page 25) Perform daily inspection to avoid avoidable malfunction or risk of accident.</p> <p> Mandatory Action</p> <p></p>	<p>■ Carry out regular and preventive maintenance. Conduct regular inspections and maintenance on the Moving Walk to detect and prevent any problem before it occurs. Please contact Toshiba for further details.</p> <p> Mandatory Action</p>
<p>■ Stop the Moving Walk immediately in the event of malfunction, when smoke is emitted, there is any strange sound, etc. (Refer to page 16 for Shutdown). Stop operation; otherwise, it may result in a fire or malfunction. Please contact the maintenance service company immediately.</p> <p> Mandatory Action</p> <p></p>	<p>■ When water penetrates due to heavy rain, etc., stop operation immediately (Refer to page 16 for Shutdown). Continuing operation under such circumstances may lead to an accident. Please contact the maintenance service company after discontinuing operation.</p> <p> Mandatory Action</p> <p></p>
<p>■ Do not repair, remodel or disassemble. This may result in electric shock, serious injury, or malfunction. Please contact the maintenance service company if any problems occur.</p> <p> Prohibited</p> <p></p>	<p>■ Do not pour liquids, such as water, or apply wax etc. on the pallet and/or landing plate. This may increase the risk of slipping on the pallets and landing plate surface, which may lead to an accident. Also, leakage of liquids into the Moving Walk may result in electric shock or malfunction.</p> <p> Prohibited</p> <p></p>
<p>■ Do not remove the landing plate. Since it houses a control panel, motor, etc. inside, this may result in an accident.</p> <p> Prohibited</p> <p></p>	<p>■ Do not operate key switches with wet hands. This may result in an accident.</p> <p> Prohibited</p> <p></p>

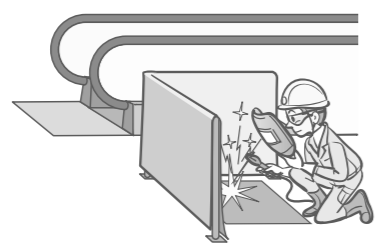
Safety Precautions

The following precautions apply to the Owner and the Operator of Moving Walks.

! WARNING	
<p>■ Ensure a Moving Walk is free of passengers and/or objects before starting and stopping it. If it is made to start and stop with a person or object present, it may result in undesirable accident.</p> <p style="text-align: center;">! Mandatory Action</p> 	<p>■ Stop the Moving Walk before cleaning and maintenance (Refer to page 16 for Shutdown). Failure to do so may result in an accident.</p> <p style="text-align: center;">! Mandatory Action</p> 
<p>■ Do not hold an event which may create a crowd around the landing plate from the Moving Walk. The crowd will prevent passengers from getting off the Moving Walk and lead to an accident.</p> <p style="text-align: center;">Prohibited</p> 	<p>■ Do not use a stopped Moving Walk as seats. Overloading will cause it to descend, which may result in an accident.</p> <p style="text-align: center;">Prohibited</p> 
<p>■ If any work is to be done involving fire/sparks/heat, please provide adequate instructions for fire prevention to the personnel responsible for the work. Sparks produced from the work may get into Moving Walk and cause an accident.</p> <p style="text-align: center;">! Mandatory Action</p> 	<p>■ Set up barricades when you suspend the Moving Walk service to prevent people from using the Moving Walk as stairs; otherwise, an accident may occur. Persons may trip or fall.</p> <p style="text-align: center;">! Mandatory Action</p>
<p>■ The operator should keep the key after it is removed from the key switch. If the key inserted into the switch, it may cause an accident.</p> <p style="text-align: center;">! Mandatory Action</p>	<p>■ Affix warning labels at places where the passengers can notice them easily. Passengers should be alerted to prevent accidents and breakdowns. The operation supervisor should guide persons in using the Moving Walks.</p> <p style="text-align: center;">! Mandatory Action</p>
<p>■ When holding an event, staff the Moving Walk platform with guides and ensure there is space for boarding. Users getting off a Moving Walk but remaining at its exit may cause others to fall.</p> <p style="text-align: center;">! Mandatory Action</p>	<p>■ Set up barricades when you suspend the Moving Walk service to prevent people from using the Moving Walk as stairs; otherwise, an accident may occur. Persons may trip or fall.</p> <p style="text-align: center;">! Mandatory Action</p>

Guide passengers with the following instructions:

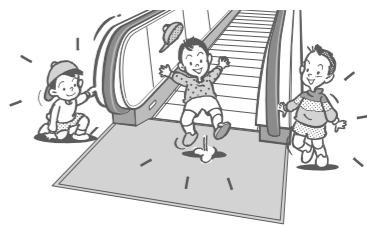
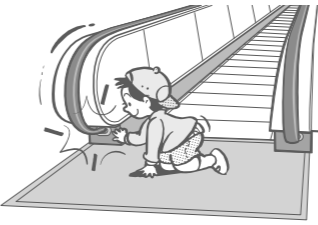
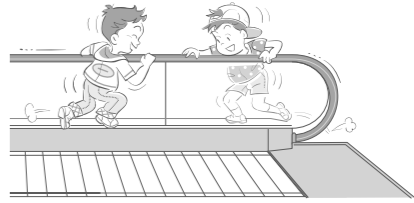
! DANGER	
<p>■ Do not ride on the handrail and deck board. This may cause injury and accident.</p> <p style="text-align: center;">Prohibited</p> 	<p>■ Do not lean your body (any part of you) past the handrail, or lean against a handrail. This may cause injury and accident.</p> <p style="text-align: center;">Prohibited</p> 
<p>■ Do not run or walk on the pallets. This may cause an accident.</p> <p style="text-align: center;">Prohibited</p> 	<p>■ Do not run on and off the pallets. This may lead to an accident.</p> <p style="text-align: center;">Prohibited</p> 
<p>■ Do not lean against the glass (or a panel). This may lead to an accident.</p> <p style="text-align: center;">Prohibited</p> 	<p>■ Do not allow children to play around the Moving Walk. This may lead to an accident.</p> <p style="text-align: center;">Prohibited</p> 
<p>■ Do not touch the pallets, comb, skirt guard panels, or handrail inlet with hands. This may lead to serious injury and an accident.</p> <p style="text-align: center;">Don't touch</p> 	<p>■ Do not climb or walk on the deck boards. This may lead to an accident.</p> <p style="text-align: center;">Prohibited</p> 

Safety Precautions

Guide passenger with the following instructions:

! WARNING

■ **Do not use Moving Walk in the event of a fire and/or earthquake.**
This may lead to matters becoming worse.



Prohibited



■ **Do not use in the opposite direction.**
Falling might cause an accident.



Mandatory Action



■ **Do not pull a handrail or kick away the skirt guard panel etc.**
The safety mechanism may trigger an emergency stop, or result in unsynchronized motion of handrail and pallets, causing an accident.



Prohibited



■ **Stand within the yellow line.**
If you stand on the yellow line, your feet may be injured.



Mandatory Action

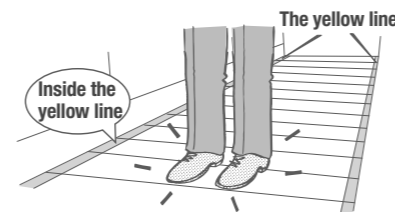

■ **Do not ride with clothes that may be caught by the Moving Walk such as a long dress.**
The dress may become caught by the Moving Walk and lead to an accident.



Prohibited



■ **Hold the handrail firmly.**
This will help to prevent the occurrence of an accident.



Mandatory Action



■ **When small children get on, their parent or guardian needs to hold their hand.**
Not holding their hand or letting them use the Moving Walk alone may result in an accident.



Mandatory Action



■ **Do not step on the comb when you are getting on or off a Moving Walk.**
Doing so may lead to an accident.



Mandatory Action



Guide passengers with the following instructions:

! CAUTION

■ **Do not carry large baggage on the Moving Walk.**
You may tumble down with the baggage, or the baggage may hit other passengers and result in an accident.



Prohibited



■ **Do not place any package, etc., on a pallet, handrail, deck board, or landing plate.**
The package, etc., may fall, and cause serious injury and an accident.



Prohibited



■ **Do not carry any long objects.**
You may lose balance, leading to an accident. The object may become stuck between the moving Moving Walk and the ceiling, causing damage to pallets and an accident.



Prohibited



■ **Do not use a stopped Moving Walk as stairs.**
This may lead to an accident.



Prohibited



■ **Do not sit on the pallets.**
It may cause serious injury.



Prohibited



■ **Do not ride with animals.**
It may lead to an accident.



Prohibited



■ **Do not stop at the landing plate once getting off from the Moving Walk.**
The way of other passengers will be blocked, causing an accident.



Prohibited



■ **Do not touch pallets with thin or pointy objects, such as the point of an umbrella.**
It may be caught in between the grooves, leading to an accident or damaging the pallets.





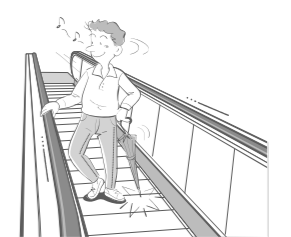









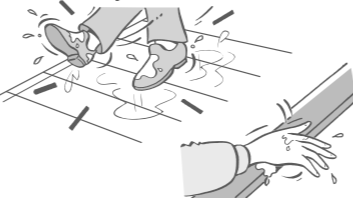

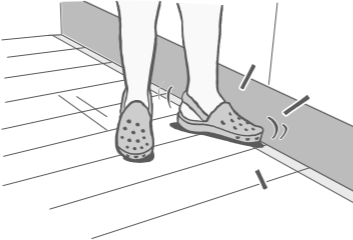

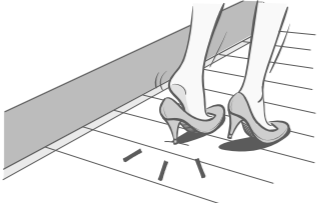

Prohibited

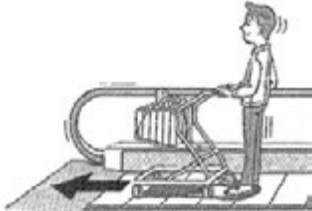

Safety Precautions

Guide passengers with the following instructions:

 CAUTION	
<p>■ Do not smoke while riding a Moving Walk. This may lead to an accident.</p>  <p>Prohibited</p> 	<p>■ Do not get on a Moving Walk with wet shoes, or hold a handrail with wet hands. Slippery pallets and handrails may lead to an accident.</p>  <p>Prohibited</p> 
<p>■ Do not force the head or heels of footwear made of soft material, such as rubber or vinyl products, into the clearance between skirt guard panels or pallets. This may cause an accident if the object is caught between a skirt guard panel or pallet. Moreover, this will trigger the safety mechanism and an emergency stop, which may lead to an accident.</p>  <p>Prohibited</p> 	<p>■ Do not ride the Moving Walk barefoot. This may lead to serious injury.</p>  <p>Prohibited</p> 
<p>■ Be careful not to let stiletto heels get caught in between the Moving Walk pallets. Stiletto heels may become stuck in between the grooves or comb, leading to an accident.</p>  <p>Mandatory Action</p> 	<p>■ Do not use the Moving Walk with a child carried in a cart. This may cause injury and an accident.</p>  <p>Prohibited</p> 
<p>■ When using a wheelchair, please ride together with an assistant person. Not doing so may lead to an accident.</p>  <p>Mandatory Action</p>	<p>■ Please push a cart stationary on a pallet to get off a Moving Walk. Not doing so may cause injury and an accident.</p>  <p>Mandatory Action</p> 
<p>■ Please lock the brakes when using wheelchairs and strollers on a slope-type Moving Walk. Not doing so may lead to an accident.</p>  <p>Mandatory Action</p>	<p>■ Before using a stroller, please consider safety. Using a stroller may lead to an accident.</p>  <p>Mandatory Action</p>
<p>■ Please don't move a wheelchair, stroller, or cart on the pallets. This may cause an accident.</p>  <p>Prohibited</p>	

Guide passengers with the following instructions:

A slope-type Moving Walk is not recommended for use by wheelchairs or strollers.

 CAUTION	
<p>■ If using a cart, ride with the wheels locked and stand safely on a pallet. You may tumble down with the cart, or the cart may hit other passengers, resulting in an accident.</p>  <p>Prohibited</p> 	
<p>■ Do not use the Moving Walk with a child carried in a cart. This may cause injury and an accident.</p>  <p>Prohibited</p> 	<p>■ Please push a cart stationary on a pallet to get off a Moving Walk. Not doing so may cause injury and an accident.</p>  <p>Mandatory Action</p> 
<p>■ When using a wheelchair, please ride together with an assistant person. Not doing so may lead to an accident.</p>  <p>Mandatory Action</p>	<p>■ Before using a stroller, please consider safety. Using a stroller may lead to an accident.</p>  <p>Mandatory Action</p>
<p>■ Please lock the brakes when using wheelchairs and strollers on a slope-type Moving Walk. Not doing so may lead to an accident.</p>  <p>Mandatory Action</p>	<p>■ Please don't move a wheelchair, stroller, or cart on the pallets. This may cause an accident.</p>  <p>Prohibited</p>

Safety Devices

Safety devices in Moving Walk.

Moving Walk

All of these safety devices trigger an emergency stop. To resume operation, please refer to page 19.

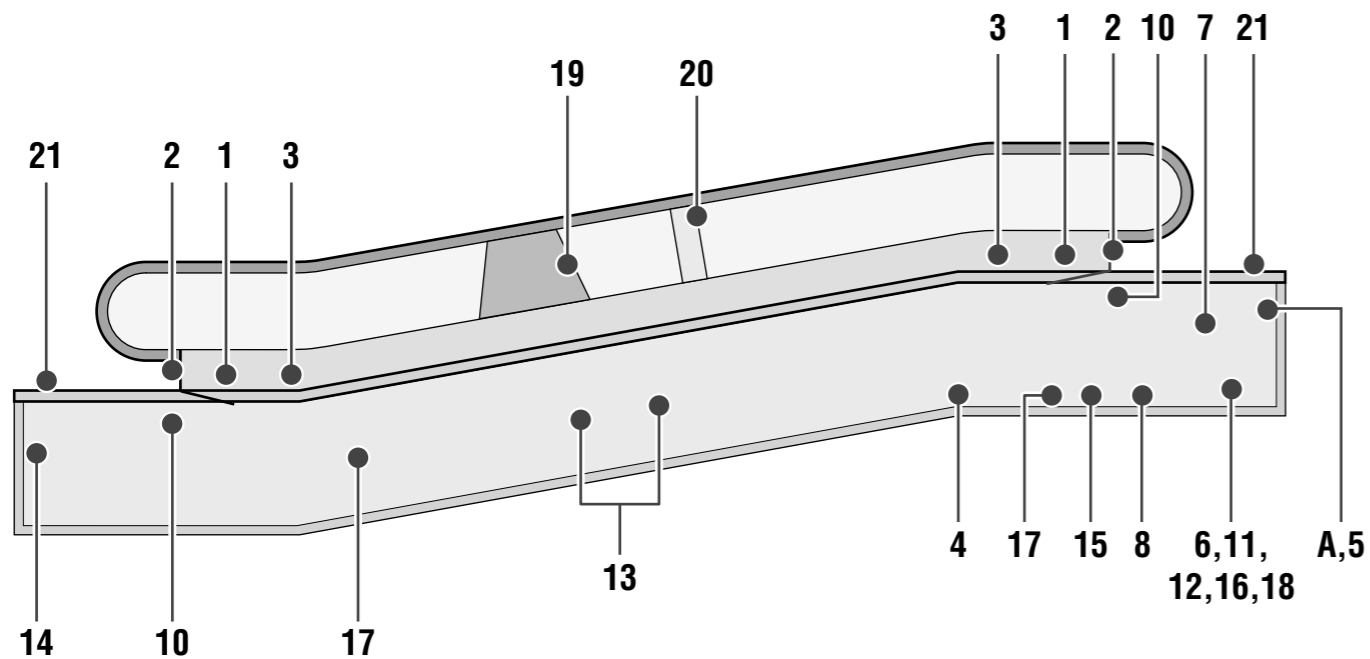

The installation location of safety devices (outline)

Apply below the specification for angle of inclination 12° or 0°.

Mark of Applications ○ : Applied
▲ : Optional

Position	no.	Device name	Application
			Standard
Upper floor	A	PESSRAE	○
	1	Emergency stop button	○
	2	Handrail inlet safety device	○
	3	Comb safety device	○
	4	Handrail speed monitoring device	○
	5	Electric-circuit protection device	○
	6	Electromagnetic brake	○
	7	Broken drive-chain detective device	○
	8	Pallet drop out detective device	○
	10	Pallet cover	○
	11	Over speed and reverse operation monitoring device	○
	12	Motor overheat protection device	○
	15	Auxiliary brake	▲
	16	Stopping distance detector	○
	17	Pallet missing detector	○
Middle floor	13	Pallet sag safety device	▲
	19	Running up prevention device	▲
	20	Emergency stop button	▲
Lower floor	1	Emergency stop button	○
	2	Handrail inlet safety device	○
	3	Comb safety device	○
	10	Pallet cover	○
	14	Broken pallet chain detection device	○
	17	Pallet missing detector	○
	21	Landing plate switch	○

Based on application: Standard=GB16899:2011

Names and Functions of Moving Walk Parts

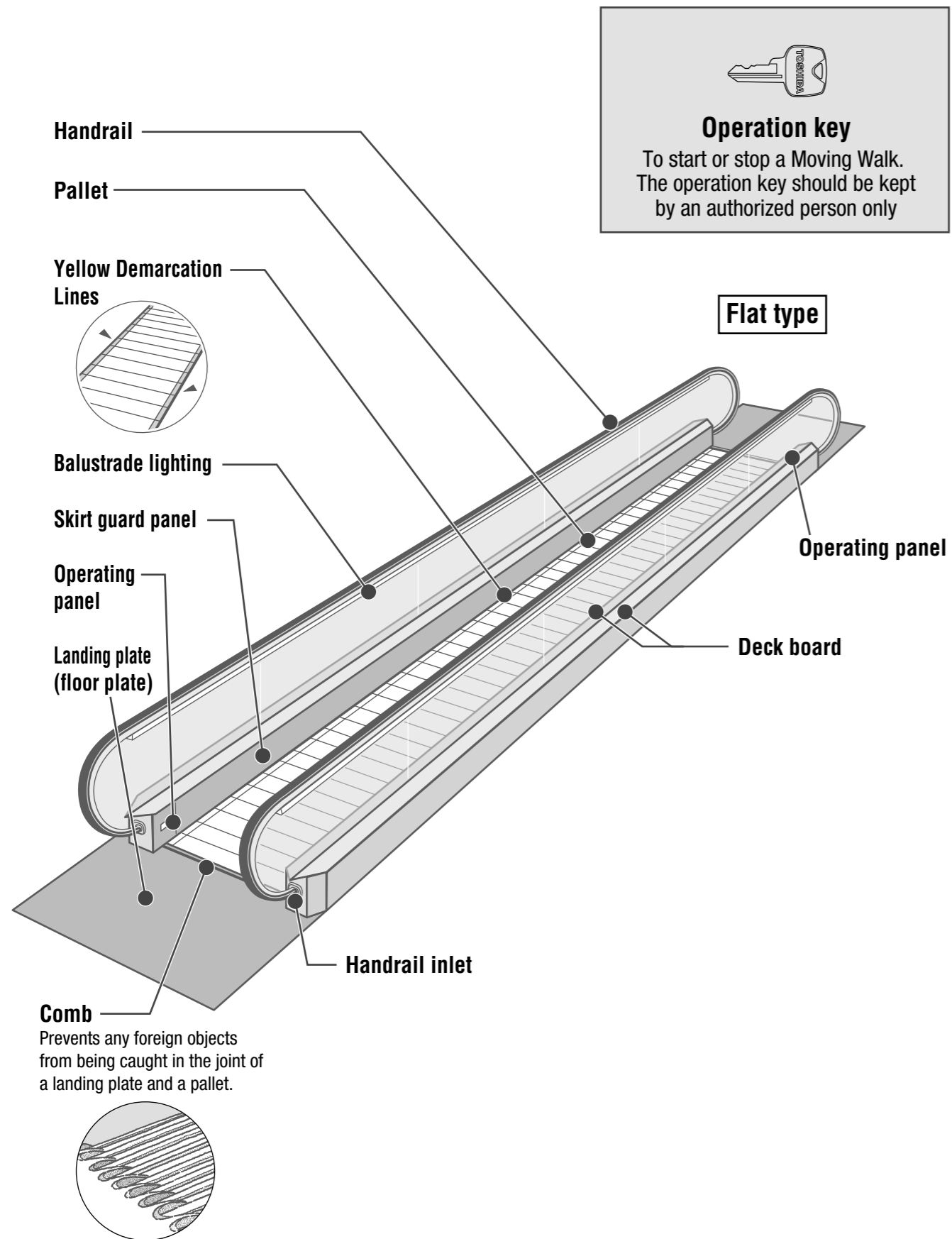

Symbol	Operating panel feature	Explanation
A	Emergency stop button	In case of emergency, stop the Moving Walk immediately by pressing this button. The emergency stop button has a protective cover around it to prevent inadvertent operation. Press the emergency stop button firmly at the center of the cover.
B	Going “←”/Coming “→” key switch	Select the moving direction by turning the Going “←”/Coming “→” key switch.
	“UP”/“DOWN” key switch	Select the moving direction by turning the “UP”/“DOWN” key switch.
C	STOP/BUZZER key switch	Turn the switch to stop the Moving Walk or to sound a buzzer.
D	Lighting/lights-off key switch (Optional)	Turn on or turn off the lighting system.

Operating panel

Flat type

For left side of drive unit side.

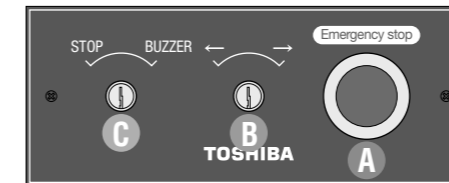

For right side of slave side.

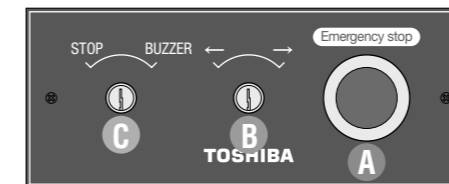

Slope type

Upper floor

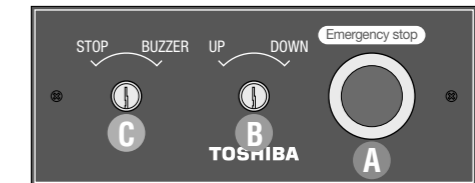

Lower floor

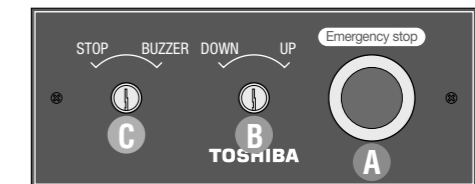

Operating Procedures

WARNING

■ Before starting or stopping the Moving Walk operation:

Make sure that there are no passengers on the Moving Walk, and that there are no objects placed on the Moving Walk.

Starting or stopping the Moving Walk when there are passengers on the Moving Walk could cause the passengers to tumble down the pallets, which may lead to death or serious injury.

■ Remove the key and return it to the person in charge after use to prevent unexpected accident.

■ Do not use keys and switches with wet hands.

There is the possibility of electric shock if water reaches internal electrical components from the operating keys, which may lead to death or serious injury. This could also cause equipment failures or breakdown.

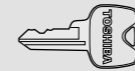

Operation key

Use to start or stop a Moving Walk.
The operation key should be kept by an authorized person only.

Startup

1

Make sure that there are no passengers on the Moving Walk, and that there are no objects placed on the Moving Walk.

- If anyone is on the Moving Walk, wait for them to get off.
- If any objects are placed on the Moving Walk, remove them.
- If the Moving Walk is interlocked with fire-proof shutters, make sure that the fire-proof shutters are completely open.

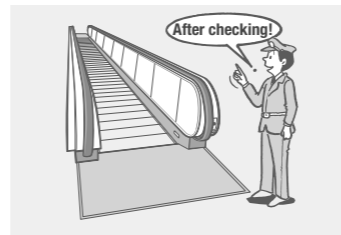

2

Turn the operating panel STOP/BUZZER switch to "BUZZER".

- The alarm sounds, informing anyone in the vicinity that Moving Walk operation is about to begin.

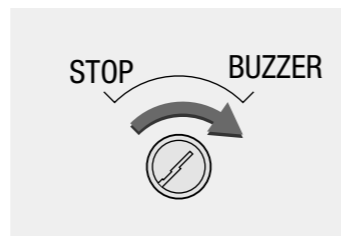

3

Turn to the desired direction of operation via the Going "←"/Coming "→" key switch for the flat type, or the "UP"/"DOWN" key switch for the slope type.

- Turn off all accompanying illumination.

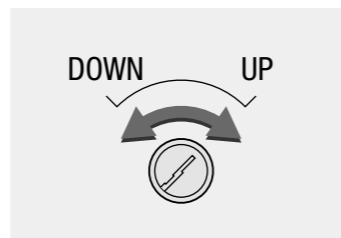
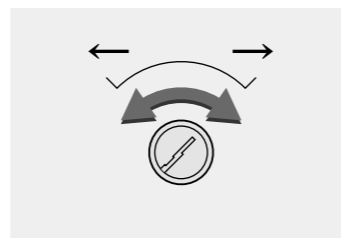

Shutdown

1

Make sure that there are no passengers on the Moving Walk.

- If passengers are present, please wait for the persons to get off from the Moving Walk.



2

Turn the operating panel STOP/BUZZER key switch to "BUZZER".

- The alarm sounds to alert the people around that Moving Walk operation is about to stop.

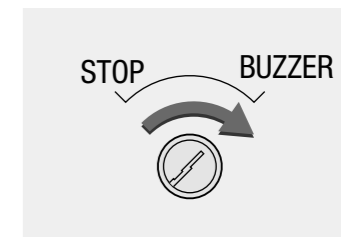

3

Turn STOP/BUZZER key switch to "STOP".

- The Moving Walk will stop.
- Turn off all accompanying illumination.

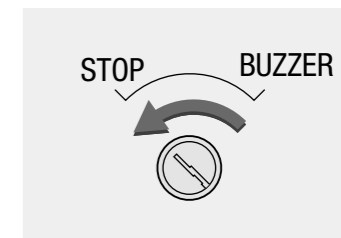

How to Ride a Moving Walk Safely

Memo

Please also read the safety precautions (Refer to page 3) and describe the right way to use Moving Walks (Refer to pages 4 to 10) to users via notices, announcements, etc. Please guide users directly, especially during rush hours.

1

Always stand within the yellow demarcation line of the pallet.

- If you stand on the yellow line, you may get your feet caught in between a moving pallet and the skirt guard panel.

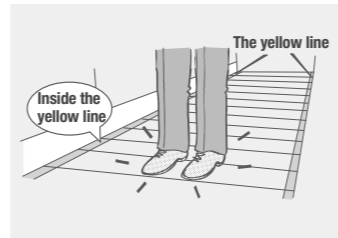

2

Hold the handrail firmly.

- Small children must be held by the hand.

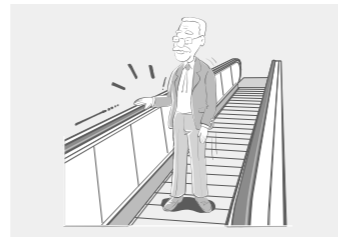

3

Do not run or walk on the Moving Walk.

- Moving Walks are not stairs; running or walking on Moving Walks may lead to an accident.

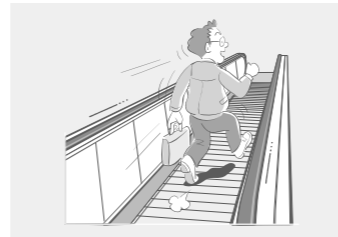

4

Step over the comb when you get on/off the Moving Walk.

- Give instructions to passengers, so they can get on and off the Moving Walk safely, especially to children, elderly and disabled passengers.



Requests

If using a cart, ride with the wheels locked and stand safely on a pallet.

.....

.....

.....

.....

.....

.....

.....

.....

.....

.....

.....

.....

.....

.....

.....

.....

.....

.....

.....

.....

.....

.....

.....

How to Ride a Moving Walk Safely

Safety Measures in Case of Emergency

In Case of Emergency Stop

When the emergency stop button is pressed or a safety device has been activated, please follow the procedures stated below:

- 1 Inspect the handrail inlet, front skirt, comb, pallets, skirt guard panel, etc. (Refer to page 25 for the check method)**
 - If any foreign object or problem is found, please contact the maintenance service company.
 - If case of accident resulting in injury or death, please refer to page 20.

- 2 Start the Moving Walk. (Refer to page 15 for how to start)**
 - In case you are unable to start the Moving Walk, please contact the maintenance service company.

In Case of Accident Resulting in Injury or Death

Stay calm and take action according to the following procedures:
Please contact the police/fire department, and maintenance service company immediately.

- 1 Press the emergency stop button immediately.**
 - The Moving Walk stops.
- 2 Take any possible safety measures to rescue the victim(s).**
 - Please contact the fire station if rescue is impossible, and in case of serious injury.
 - Stay attentive during any rescue and keep unauthorized people away from the spot.
- 3 Contact the maintenance service company.**

Examples of Rescue Methods

■ When fingers are caught in the handrail inlet.

Use tools (driver, etc.) to help the victim to draw out his/her fingers from the handrail inlet.

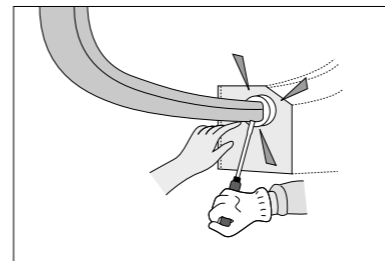

■ Hand and/or foot is caught in between the comb.

Remove the comb with a screwdriver.

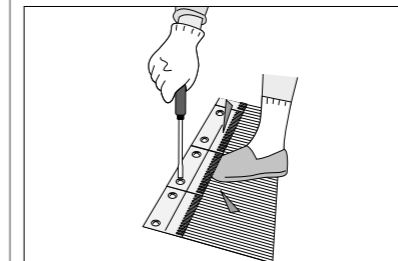

■ The foot is caught in between the pallet and the skirt guard panel.

Use tools (bar, etc.) to widen the clearance between the skirt guard and pallet.

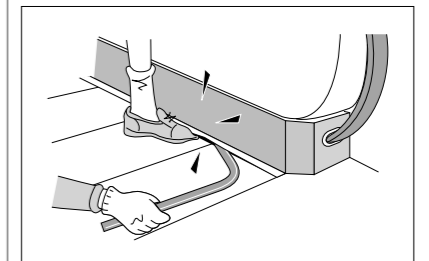

● These rescue methods are examples. Rescue may be difficult depending on the situation. In such cases, please seek professional help.

Safety Measures in Case of Disaster

In case of disaster, it is very important for the supervisors to assess the situation calmly, take action promptly, and always ensure user safety. Here, we explain the procedures to be taken in times of disaster.

In Case of Earthquake

WARNING

- Please do not use the Moving Walk in case of earthquake.
Taking refuge on a Moving Walk may make matters worse.
- When you suspend the Moving Walk service, put up barricades to prevent people from using Moving Walks as a walkway to prevent an accident.
Otherwise, a trip or fall accident may occur.

1 Notify passengers about the occurrence of an earthquake by making announcement, and alert them not to use the Moving Walk.

- Please guide the passengers, so they can take refuge safely.

2 Stop the Moving Walk. (Refer to page 16 for how to stop)

3 Carry out daily inspection, after the earthquake has subsided. (Refer to page 25)

- If any problem is detected, please contact the maintenance service company.
- If no problem is found, please resume operation (Refer to page 15 for how to start).

In Case of Fire

WARNING

- Please do not use the Moving Walk in case of fire.
Taking refuge on a Moving Walk is likely to make matters worse.
- When you suspend the Moving Walk service, put up barricades to prevent people from using Moving Walks as a walkway to prevent an accident.
Otherwise, a trip or fall accident may occur.

1 Notify passengers about the outbreak of fire by making announcement, and alert them not to use the Moving Walk.

- Please guide the passengers, so they can take refuge safely.

2 Notify the fire station immediately.

- Please also contact the maintenance service company.

3 Stop the Moving Walk. (Refer to page 16 for Shutdown)

- A fire prevention shutter may be activated, which will stop automatically.

Power Outage Notification

WARNING

■ When you suspend the Moving Walk service, put up barricades to prevent people from using Moving Walks as a walkway to prevent an accident.

Otherwise, a trip or fall accident may occur.

1

Notify users of the power outage via notice, announcement, etc., in advance.

2

Stop the Moving Walk, before the power is cut off.
(Refer to page 16 for how to stop)

3

Resume operation, after the power is restored.
(Refer to page 15 for how to start)

In Case of Rainstorm

WARNING

■ If water penetrates into the Moving Walk due to heavy rain, etc., please stop the Moving Walk immediately (Refer to page 16 for how to stop).

Continuing operation may lead to an accident. If equipment/parts have been exposed to water, replacement may be required.

■ When you suspend the Moving Walk service, put up barricades to prevent people from using Moving Walks as a walkway to prevent an accident.

Otherwise, a trip or fall accident may occur.

In case of rainstorm (possibility of water seepage)

1

Stop the Moving Walk. (Refer to page 16 for how to stop)

- When there is possibility of water seepage, please stop the Moving Walk.

2

Create a barrier to prevent water from flowing into the Moving Walk.

[After the rainstorm]

1

Check the landing plate to ensure there is no trace of water penetrating into the Moving Walk.

- If any water trace is detected, please stop the operation and contact the maintenance service company (Refer to page 16 for how to stop).
- If there is no trace of water seepage, please resume the operation (Refer to page 15 for how to start).
- Although the outdoor Moving Walks are designed to withstand a certain extent of rainstorm, we recommend you to stop the Moving Walk in advance, like a normal Moving Walk during a rainstorm.

[If any parts of the Moving Walk have been exposed to water during operation]

1

Please stop operation immediately and contact the maintenance service company.

- Please do not resume operation under any circumstances unless procedures such as the insulating measurement test, etc., draining, and dryness check have been done by an authorized technician.

Procedure for Daily Inspection

! DANGER

■ **Please conduct daily inspections.**

Conduct regular inspections daily to prevent undesirable problems and accidents.
Operation with safety comprised may lead to undesirable accident.

Please conduct the following inspection everyday.
If anything unusual occurs, please contact the maintenance service company.
Please check the surrounding facility installation situation at the time of test runs and round checks.
If the safety equipment is deficient, or any hindrance exists, do not operate the Moving Walk under any circumstances.

Inspection	Details of inspection
① Operational status	<ul style="list-style-type: none"> • Ensure there is no sign of abnormal sound. • Ensure there is no sign of abnormal vibration.
② Handrail	<ul style="list-style-type: none"> • Ensure there is no sign of abnormal flaw. • Match the pallet speed. • Ensure there is no sign of abnormal vibration.
③ Handrail inlet safety device	<ul style="list-style-type: none"> • Ensure there is nothing missing or damaged. • Ensure nothing is caught.
④ Comb	<ul style="list-style-type: none"> • Ensure there is nothing missing or damaged. • Ensure nothing is caught.
⑤ Pallet	<ul style="list-style-type: none"> • Ensure there is nothing missing or damaged. • Ensure nothing is caught.
⑥ Skirt guard panel	<ul style="list-style-type: none"> • Are not in contact with a pallet. • Ensure the clearance between pallets is not excessive. • Ensure nothing is caught.
⑦ Glass panel/Deck board	<ul style="list-style-type: none"> • Ensure no damage.
⑧ Skirt guard panel lighting <Optional>	<ul style="list-style-type: none"> • Ensure it operates normally and does not blink. • Ensure that there is no damage or crack on the acrylic cover of the skirt guard panel lighting. • Ensure the skirt guard panel lighting operates normally and does not flicker.
⑨ Wedge guard	<ul style="list-style-type: none"> • Ensure no damage. • Ensure it does not shift.
⑩ Partition plate for ingress prevention	<ul style="list-style-type: none"> • Ensure no damage. • Please provide partition plate prevent the passengers from falling from the clearance between the balustrade and the fall prevention fence, etc., in a landing place.
⑪ Falling object prevention net	<ul style="list-style-type: none"> • In order to catch falling objects, to prevent accident, please install a net for protection.
⑫ Speaker	<ul style="list-style-type: none"> • It is effective to use announcements over a store's public address system etc. for guidance, PR, etc. concerning the right method of getting on and off Moving Walks.
⑬ Fall prevention fence	<ul style="list-style-type: none"> • Please install a fence around the Moving Walk to prevent small children or any object from falling accidentally.
⑭ Fire prevention shutter interlock device	<ul style="list-style-type: none"> • In the event of fire, it is necessary to isolate the Moving Walk from the outside.
⑮ Deflector	<ul style="list-style-type: none"> • Ensure no damage. • Ensure it does not shift.

- Please remove any object that triggered an emergency stop in ③, ④, and ⑤ (Refer to page 16 for how to stop).
- ⑧ and ⑨ are optional, depending on the situation.
- ⑩, ⑪, ⑫, ⑬, ⑭, ⑮ : These facilities are not included in Moving Walk installation work.

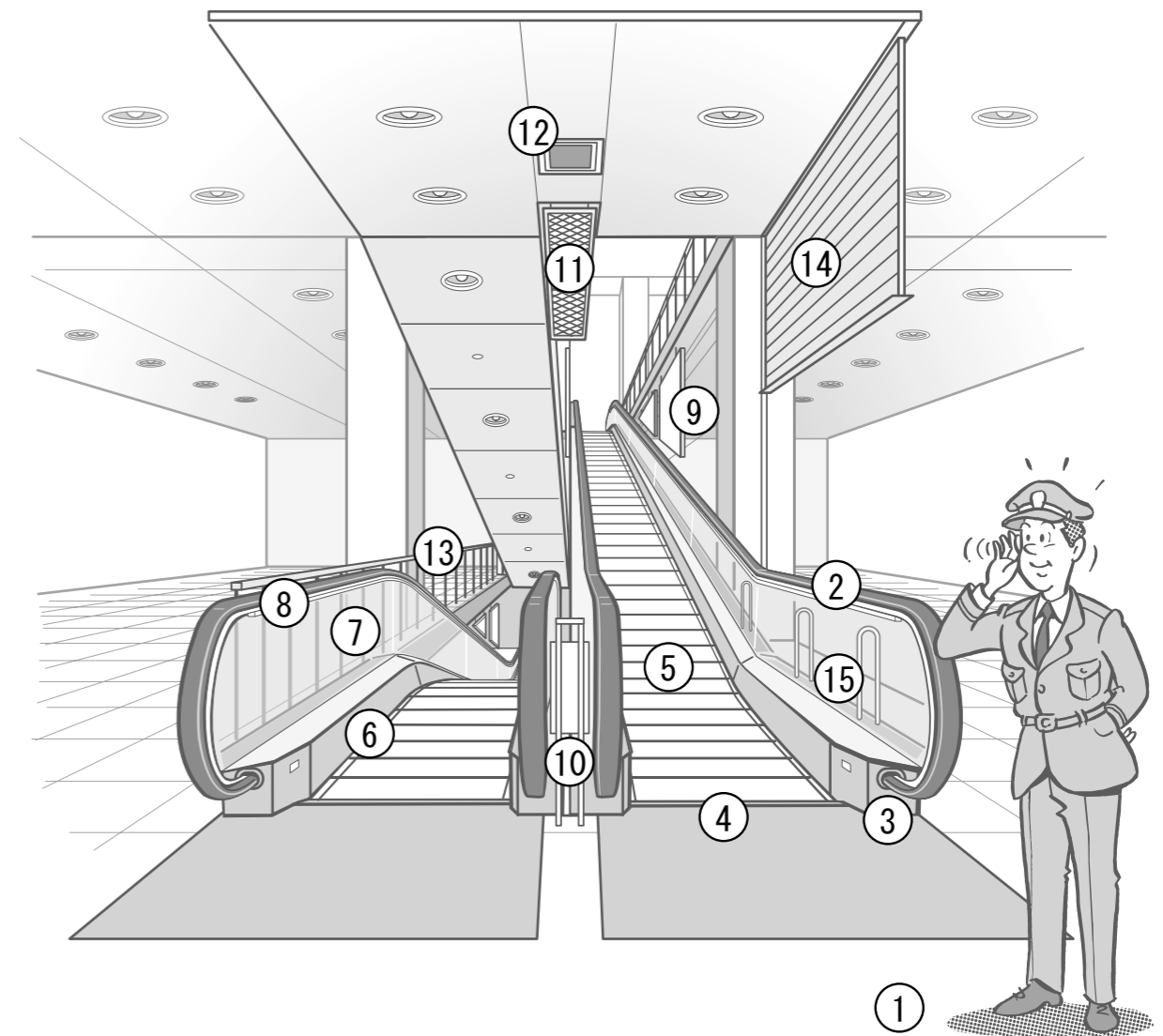

How to Clean and Maintain Moving Walks

Please stop the Moving Walk before cleaning and maintenance (Refer to page 16 for how to stop). Failure to do so may result in an accident.

! DANGER

■ Please do not pour liquids, such as water, or apply wax etc. on the pallet and/or landing plate.
This may increase the risk of slipping on the pallet and landing plate surface, which may lead to an accident. Also, leakage of liquid into Moving Walk may result in electric shock or malfunction.

Cleaning area	The cleaning method
Handrail	<ul style="list-style-type: none"> Wipe with a dry soft cloth. Wipe stubborn stains with neutral detergent diluted to about 1%. Remove the moisture with a dry cloth later. After the handrail is dried, please apply slide agent* with a cloth to the handrail surface. When the liquid is dried, please wipe the handrail with a dry cloth. Keep in mind that the handrail may get scratched if it is neglected or over-wet with too much silicone. Stop the Moving Walk. Clean only the exposed portion of the handrail. When the cleaned section is thoroughly dried, operate the Moving Walk to allow the remaining section to be exposed for cleaning. <p>*An example slide agent Toshiba Silicone emulsion TSM 630 <GE Toshiba Silicones Co., Ltd.></p>
Comb, pallets, landing plate	<ul style="list-style-type: none"> Remove rubbish, etc., with a vacuum cleaner. Remove any rubbish in the groove of the comb or pallet.
Glass panel / deck board	<ul style="list-style-type: none"> Wipe with a dry soft cloth. Wipe stubborn stains with neutral detergent diluted to about 1%. Remove the moisture with a dry cloth later. Please read the instruction manual for how to use the glass cleaner.
Illumination cover	<ul style="list-style-type: none"> Wipe the stain with neutral detergent diluted to about 1% strength. Occasionally, wipe stains with plain water. Remove the moisture with a dry cloth and apply antistatic agent. Users should read the instruction manual for how to use the antistatic agent.

Note

Please do not use benzene, thinner, gasoline, etc.
These solvent may cause degradation and discoloration of Moving Walk material.

! DANGER

■ Please apply a slide agent to the skirt guard panel once or twice a month.
Inadequate slide agent may cause shoes, etc., to become pulled into the clearance between the pallet and skirt guard panel.
■ Please do not allow the slide agent to adhere to a pallet.
Otherwise, it may lead to an accident.

Cleaning area	The cleaning method
Skirt guard panel	<ul style="list-style-type: none"> Please apply a slide agent once or twice a month. (When a fluoro-resin coating skirt is used, please apply once every three months.) <p>An example slide agent Toshiba Silicone emulsion TSM 630 <GE Toshiba Silicones Co., Ltd.></p>

M o v i n g W a l k



Safety Cautions

- Observance of relevant laws / regulations are required.
- Read the entire "Instruction Manual" carefully before use, for important information about safety, handling and operation.

TOSHIBA

TOSHIBA ELEVATOR AND BUILDING SYSTEMS CORPORATION

72-34, Horikawa-cho, Saiwai-ku, Kawasaki
212-8585, Japan
PHONE: +81-44-331-7057 FAX: +81-44-548-9597

- The data given in this catalogue are subject to change without notice.
- Revised publication effective Apr. 2017